

Transform Your Home Into a Stunning Work of Art



MOUNTAIN LAUREL HANDRAIL®





"Here are some pictures! We're getting tons of compliments!"
Rae O.

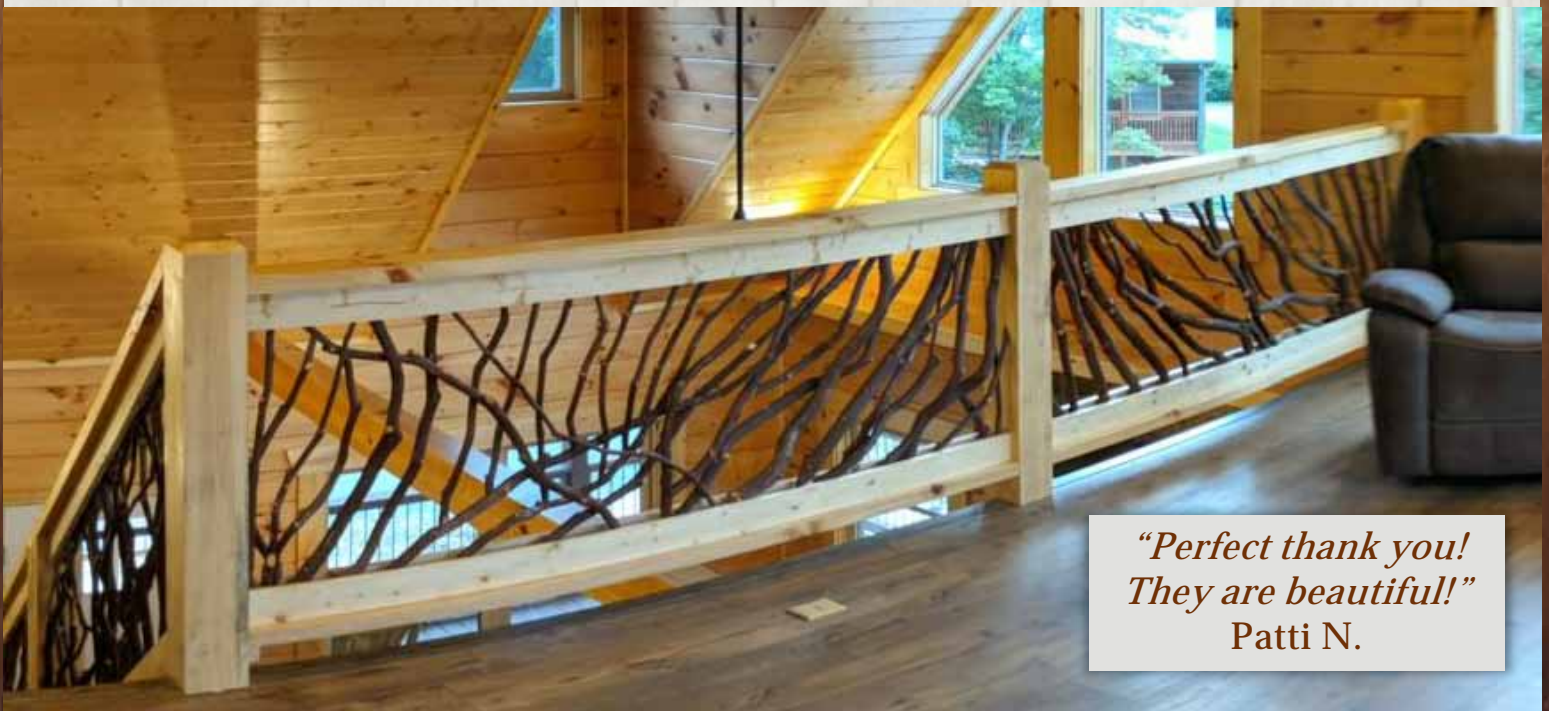

"Perfect thank you! They are beautiful!"
Patti N.

Table of Contents

Deck Railing - 2
Lissara Style - 13
Interior Railing - 19
Stair Railing - 24
Curved Railing - 29
Log Railing - 32
Custom Woodwork - 37
Laurel Furniture - 42
Railing Parts - 45
The Process - 46

You have found the best way to dramatically improve the appearance of your home!

Mountain Laurel Handrail transforms your home into a stunning work of art and attract compliments from all who see them!

MOUNTAIN LAUREL HANDRAIL[®]

Mountain Laurel Handrail
131 Franklin Plaza #304
Franklin NC 28734

awoodrailing.com
info@awoodrailing.com
828-342-0873

Deck Rail ing

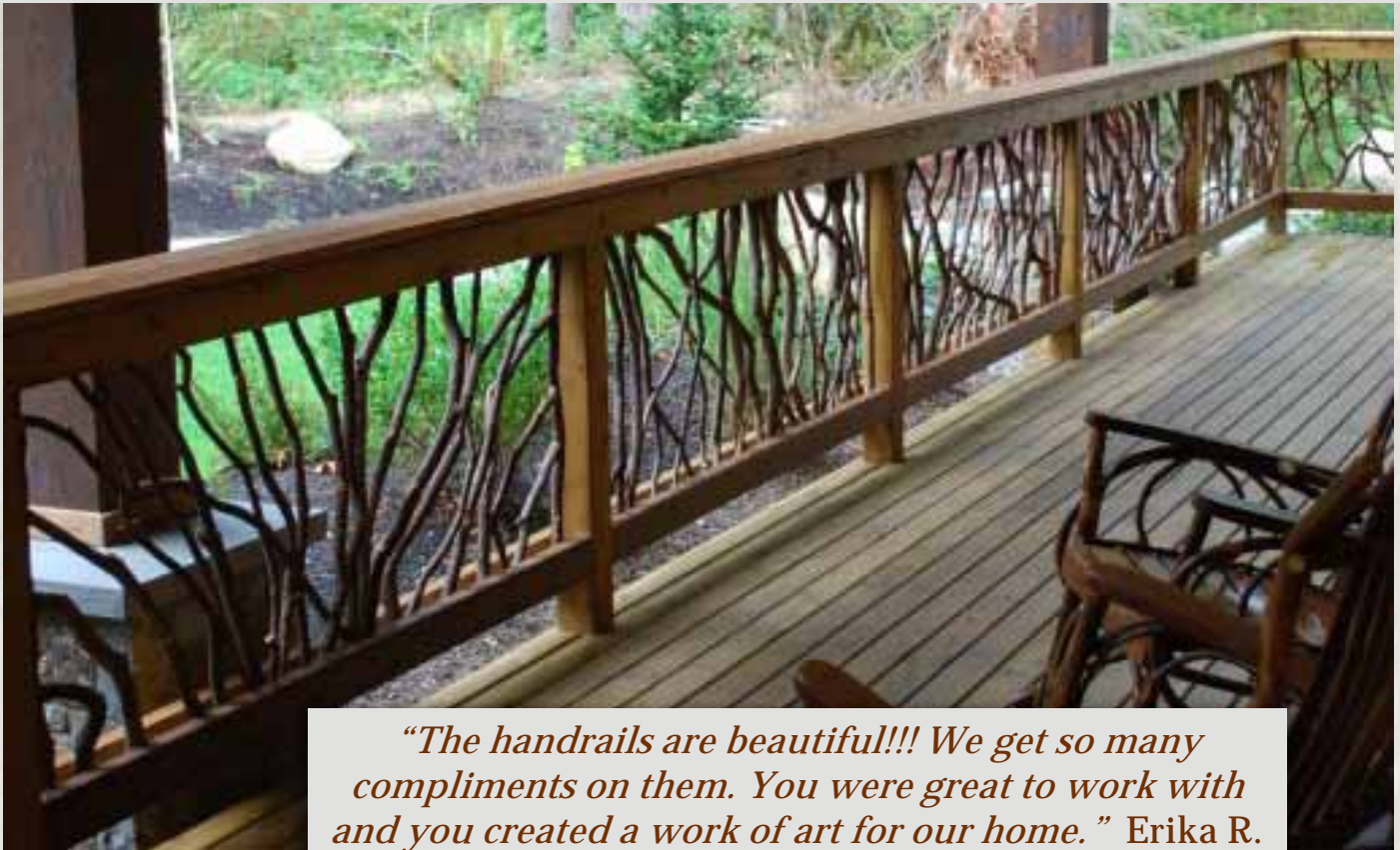

“The handrails are beautiful!!! We get so many compliments on them. You were great to work with and you created a work of art for our home.” Erika R.

That’s what Erika said about her front porch pictured here. This was the first order of Mountain Laurel Handrails that was shipped nationally in 2010. Mountain Laurel Handrails are available nationwide.

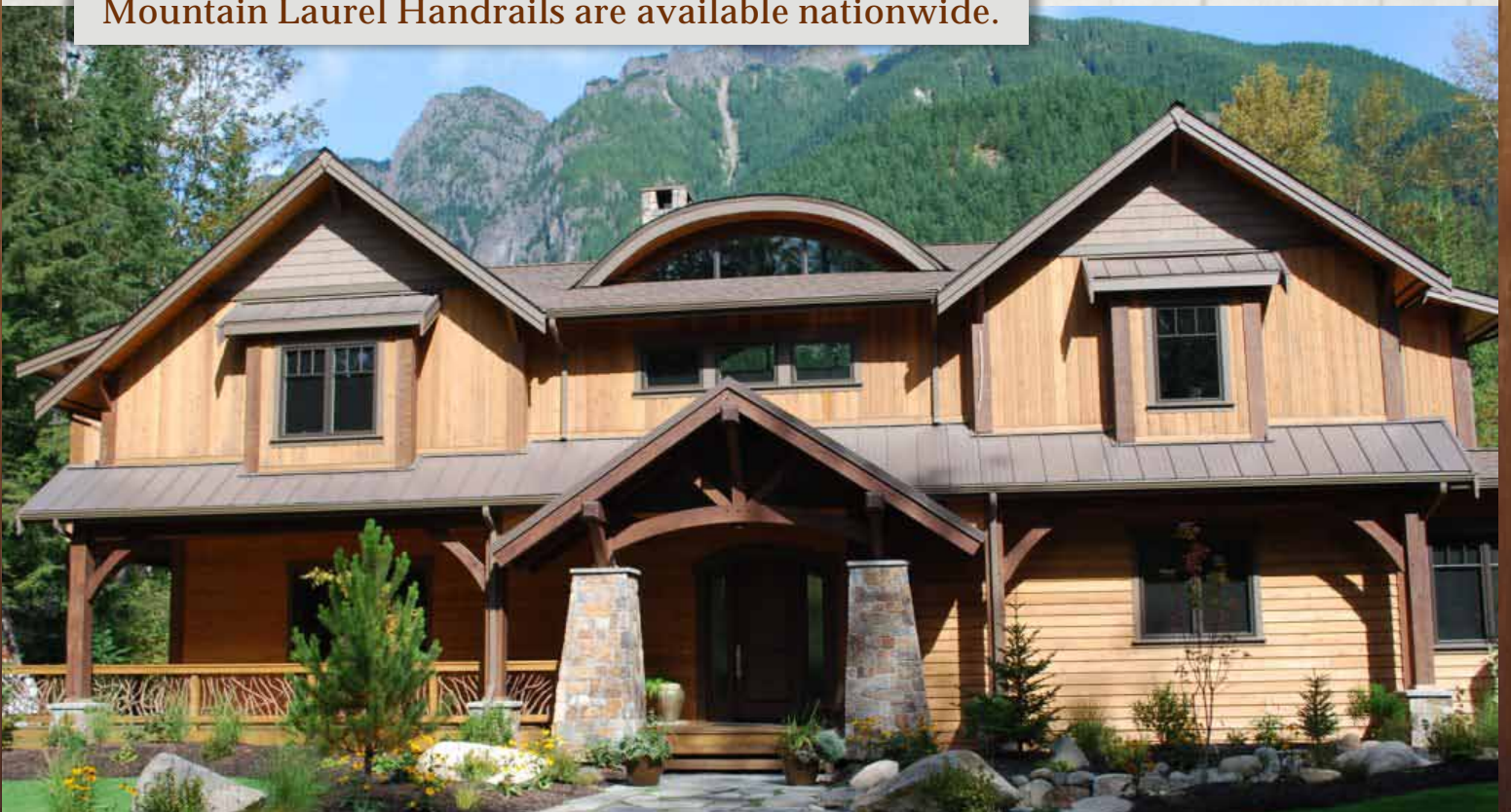

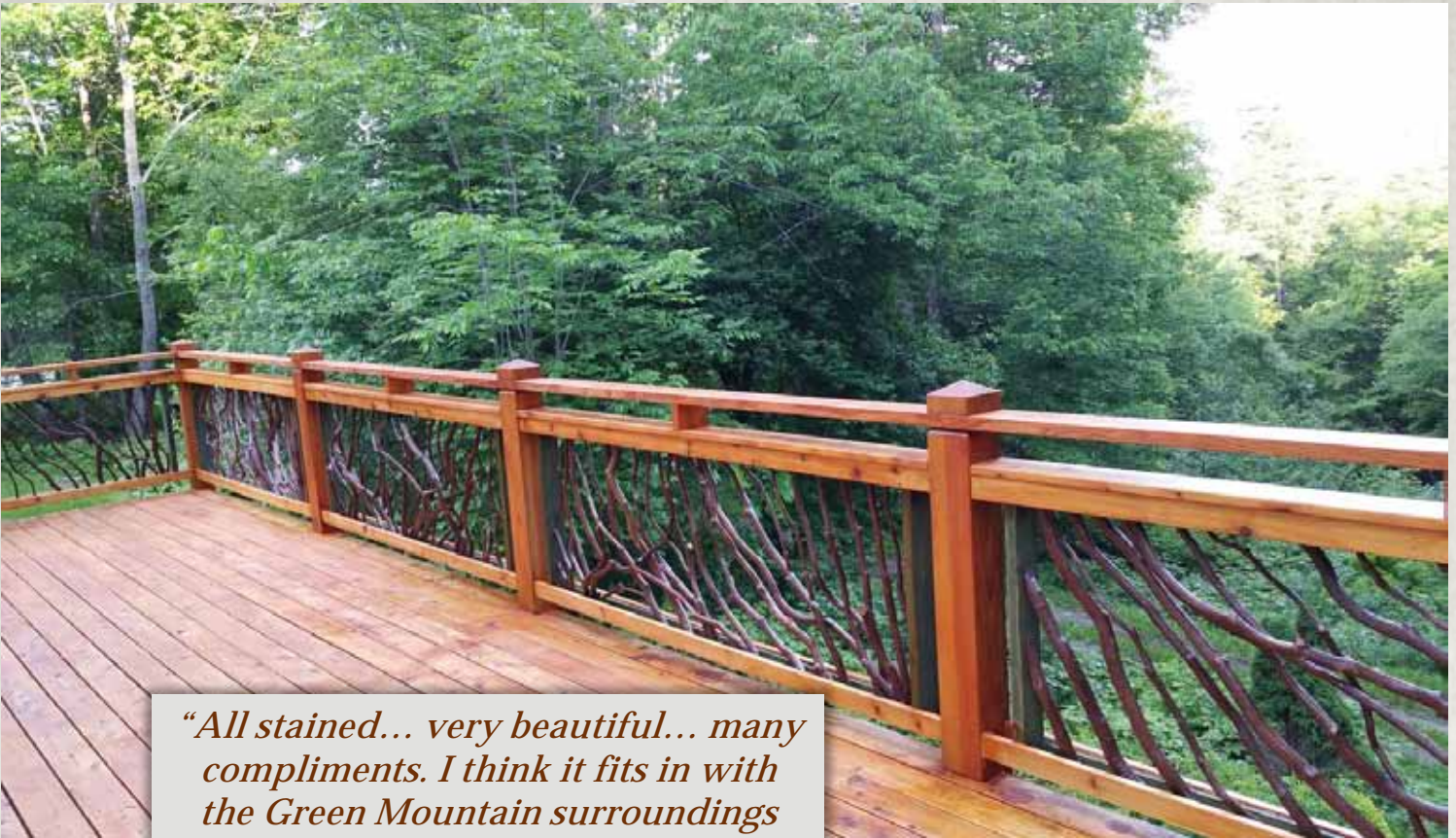

“All stained... very beautiful... many compliments. I think it fits in with the Green Mountain surroundings perfectly. My plans are to order railings for the loft and staircase next year when I finish the inside of the barn. BTW, feel free to use the pictures if you'd like. I love my deck and have had nothing but compliments about how beautiful it is and how naturally it fits in the Green Mountains of Vermont. Thanks James!” Fred B.



Deck



"I always make sure I give your info to people who visit and I love this railing!! Hope all is well with you!"
Jenna J.



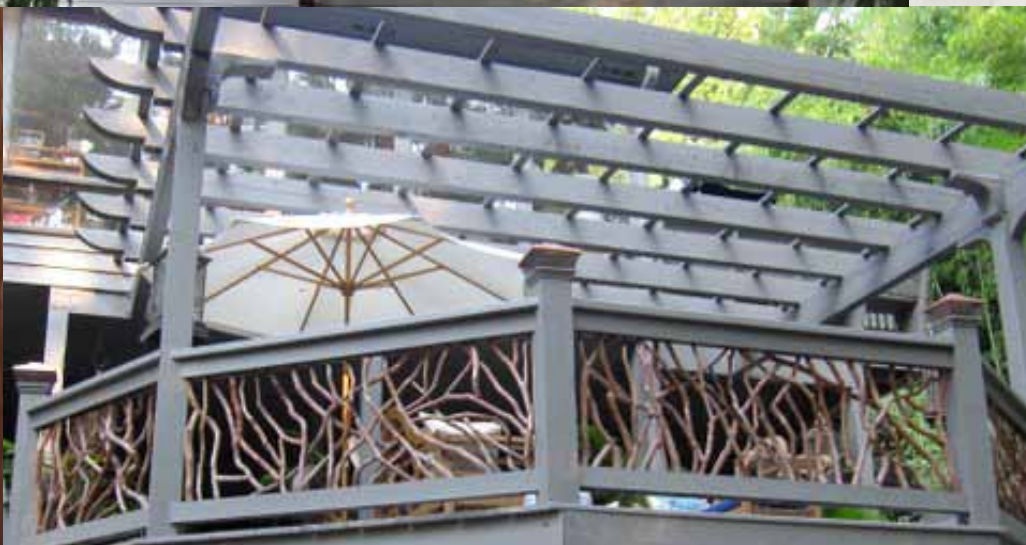

“It has been eleven years since I purchased the Mountain Laurel Handrails from James Pader and they look like they were installed today! He is an amazing craftsman and I highly recommend his work and his good spirit!”
Mitch J.



Mountain Laurel Handrails with their twisting twig balusters lend a fun and fairy-tale look to a special play park at The Children's Inn at the National Institutes of Health in Bethesda, Maryland.





Deck

"We have had Mountain Laurel Handrail on our large deck in NC for about 15 years. It's hard to say you can fall in love with your railings but I just love staring at them. They fit so well with our mountain setting that they appear nature built them. So much better than the usual typical railing systems. They have stood up amazingly well in all these years and still retain their original bark and have not deteriorated. I highly recommend Mountain Laurel Handrails for anyone looking for that natural look. I even added these to an outside deck I have in Florida. I get many positive comments and compliments. We love them!" Ed R.



"Every time I get an email from you I remember I haven't sent a photo to you of how ours turned out! I'm so sorry to be so slow with it, but here is a nice one taken from the porch during a snowfall from a couple of winters ago. We love the railing so much! It's the one thing people love the most about our home! Warm regards," Shawn C.



Mountain Laurel Handrail®
Made in the USA

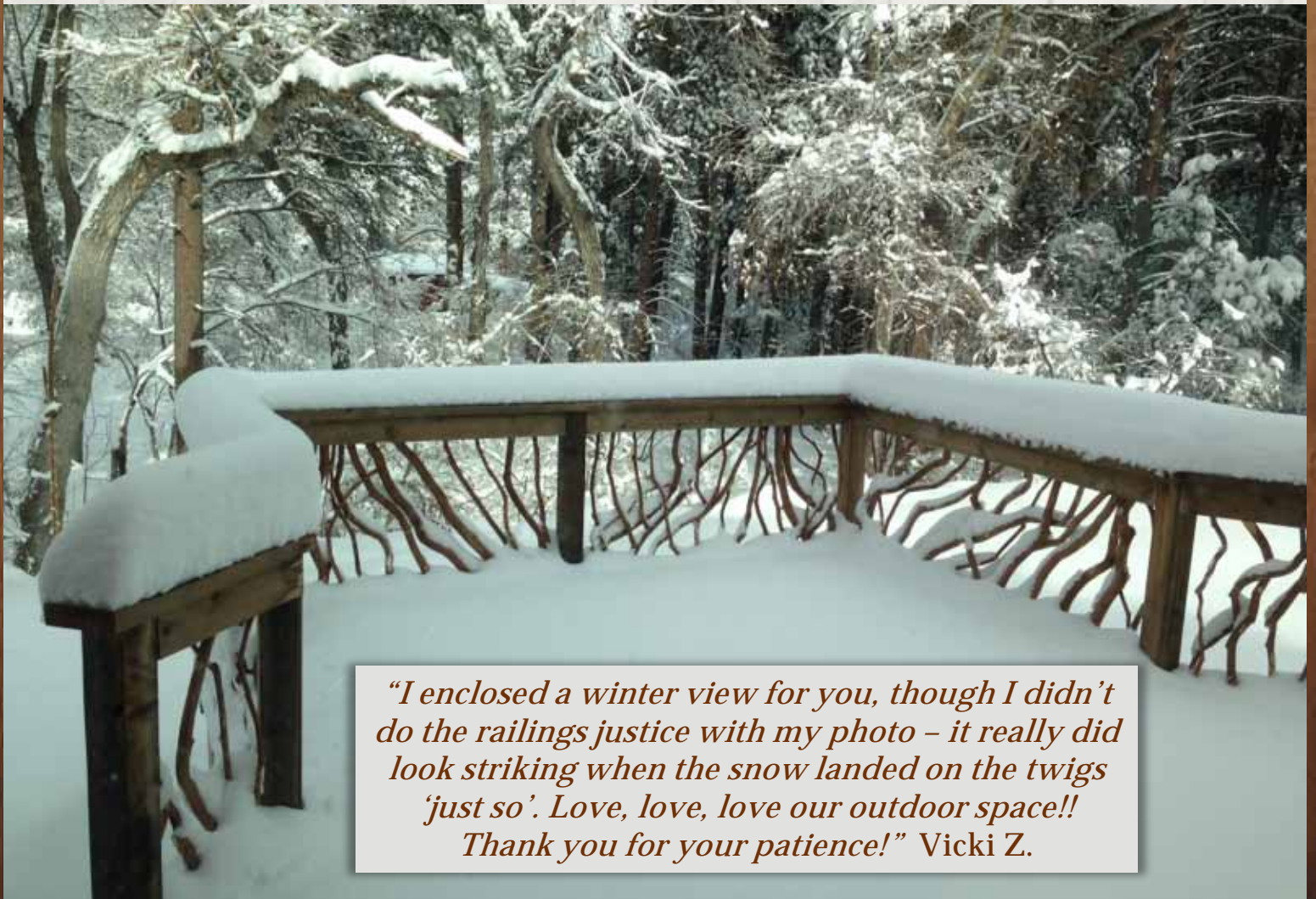

"I enclosed a winter view for you, though I didn't do the railings justice with my photo - it really did look striking when the snow landed on the twigs 'just so'. Love, love, love our outdoor space!! Thank you for your patience!" Vicki Z.

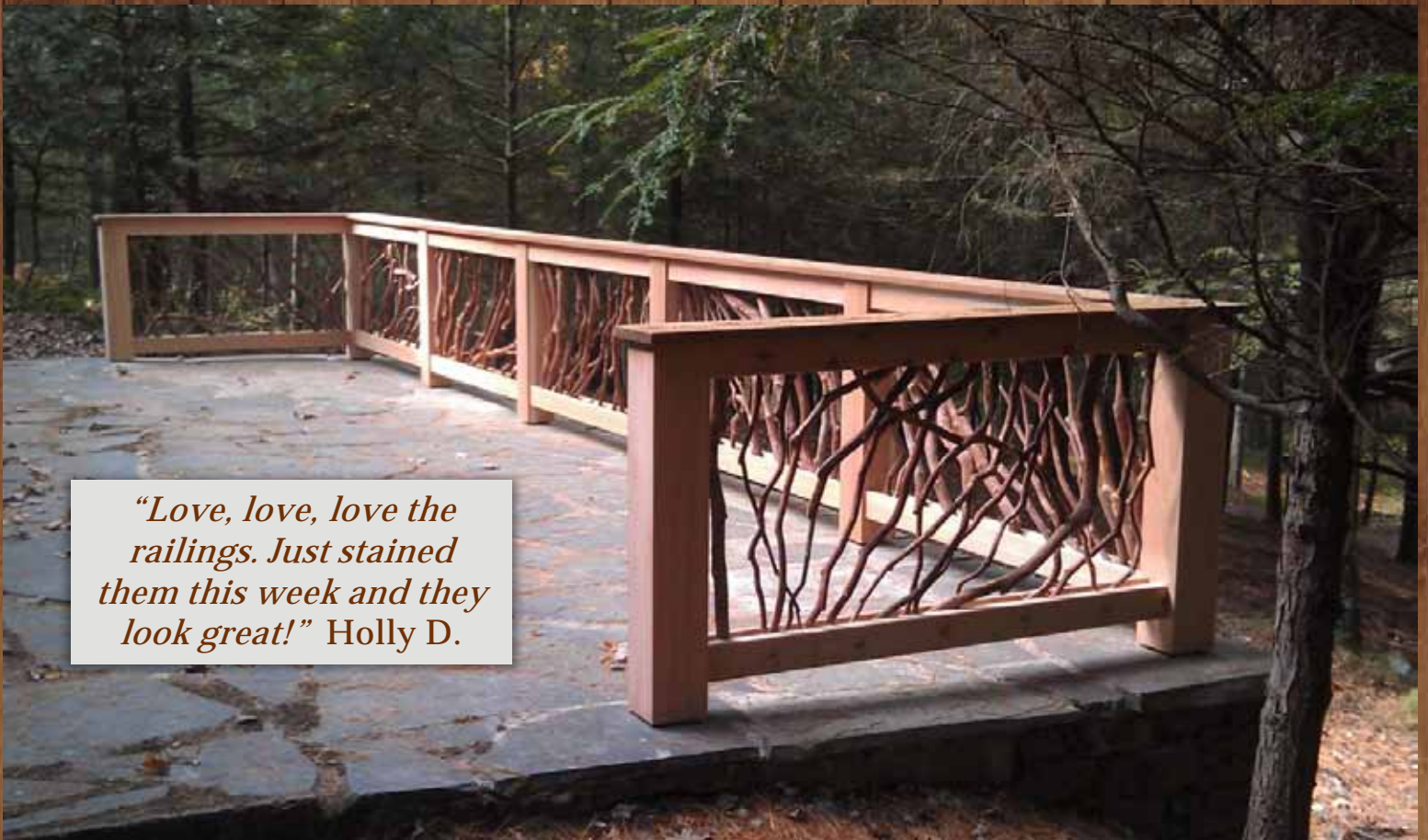

“Love, love, love the railings. Just stained them this week and they look great!” Holly D.

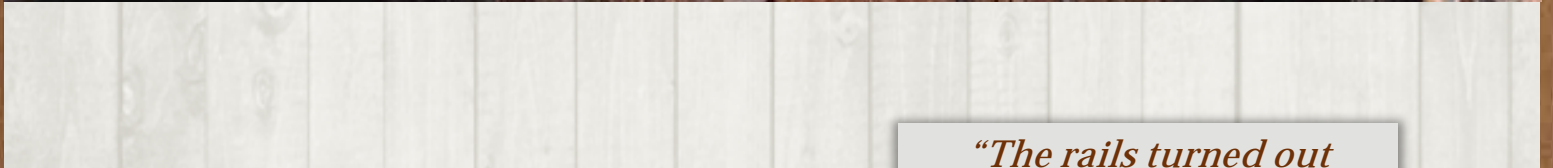

“The rails turned out great. I’ve attached lots of pictures. Thanks again, we love them!” Lorie H.



"This is a 1930s brick house with weeping mortar. This is a re-build of the existing airing porch that was typical on these storybook cottage homes. Thanks again, we really love them!" Amy D.



*"We love your railings!!"
Joe F.*





"I finished installing the handrails this weekend - it turned out great! It took me about six hours total to trim the sections and secure them in place. I still need to extend the deck forward and I'll add the last two sections when that's done. Here's the picture of the current finished product. You and your team do great work! Please tell them thanks." Scott C.

Lissara Style

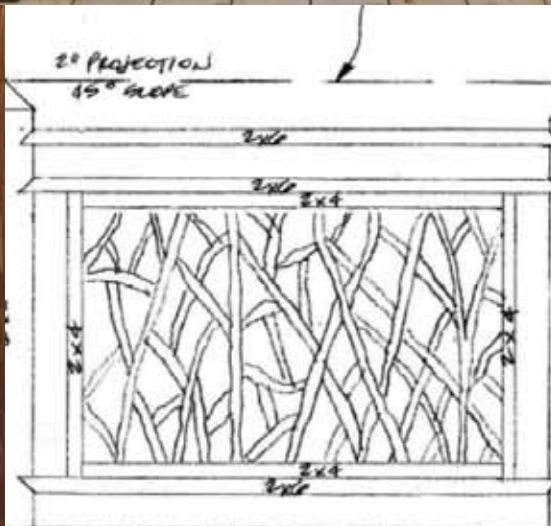
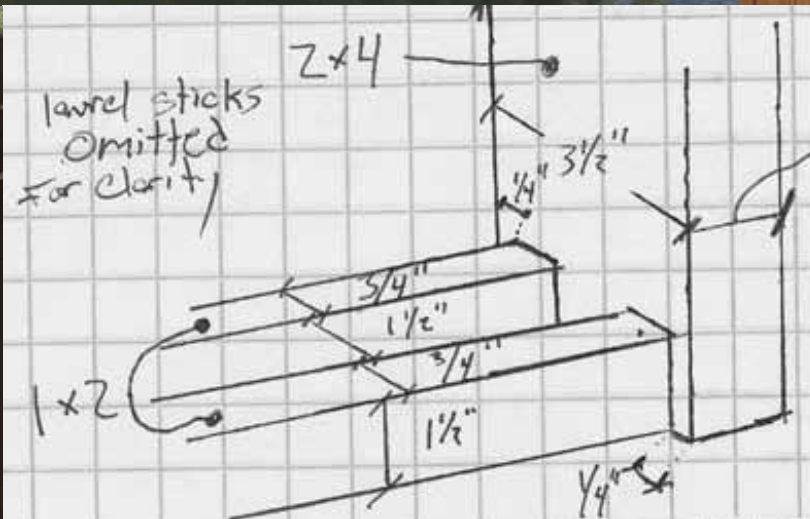



“Hope you are doing well! We are working on the railing install and they look fantastic. I have attached some photos for you to see. The homeowner has asked if we could add matching Laurel Banisters. Do you have an option for this? Thanks & Be Safe”
Paul Jester, PLA, ASLA





“As you may be able to tell from the pictures, the railings have been up for several weeks; I am just now getting around to send you the pictures I promised. As I hope you can tell, the project turned out very well, and we are delighted with the railings.” Regis F.



“We got the railing today! It is beautiful! We'll send pics of it installed. By the way, we'll order more for the back deck in a month or so. Thanks!” Holly Y.



“We finally finished the back deck and I attached some pictures. Also would like to get a quote to start on a new order for the front deck.” Josh E.





*"We received and installed the Lissara style handrails - they look great! We decided to also put your rails on our side deck. So I need Lissara style panels for that deck as well as the Lissara style panels for the stairs."
Tom I.*





"The wood railing looks terrific installed! Looking forward to enjoying the porch soon." Laura L.



Interior Railing



"I thought you might like the finished pictures. The railings are beautiful and everything I had hoped for. They really are the finishing touch on a beautiful lakefront cabin in the woods of PA. You are most welcome to use these in your advertising and are welcome to visit and see the results for yourself. Many thanks. I can't express how pleased we are with both the product and your service." Pat C.





"We love the pics. Can't wait to see the railings in person. Let us know if we can write you a recommendation... and please feel free to use pics of our railing on your site. We are really excited about our renovations and the railings! Thanks!" Anna F.



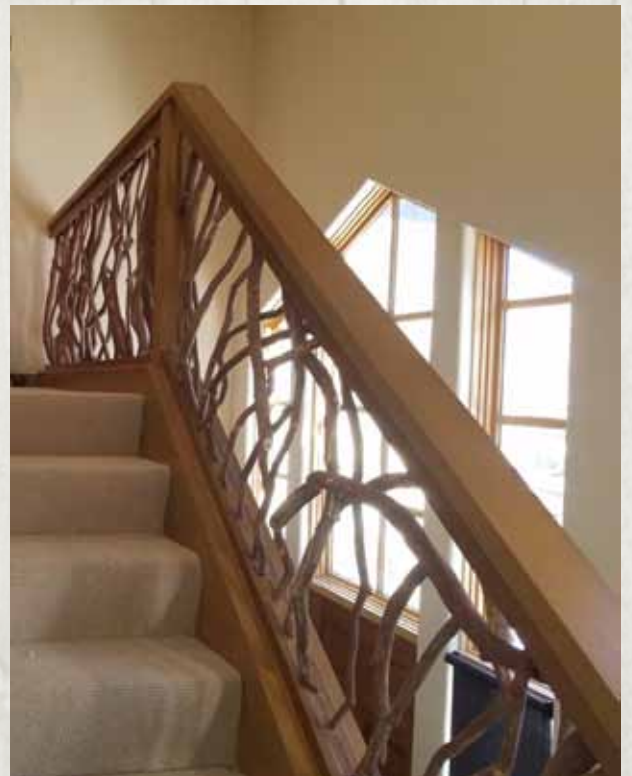

"Here are photos of the completed railing installation in Beaver Creek, CO. It looks great and the owner is very happy with the finished product. Thank you!"
Tony Faulhaber, Faulhaber Construction





*"The railings look fantastic! Thanks for your great customer service. I really appreciate it."
Francis G.*





“Everything has turned out pretty much as I envisioned and we are quite happy with the results. The panels fit properly and were easy to install. And we added some trim on the top of the rails and some of the edges for a more finished look. I’m happy to say we get a lot of positive comments and I’ve given info on your product to several people. Thanks for all your help getting the rails ordered!” Bev M.



Stair Railing



"It looks even better than I imagined... and I have a pretty good imagination!! Thanks." Kristin R.

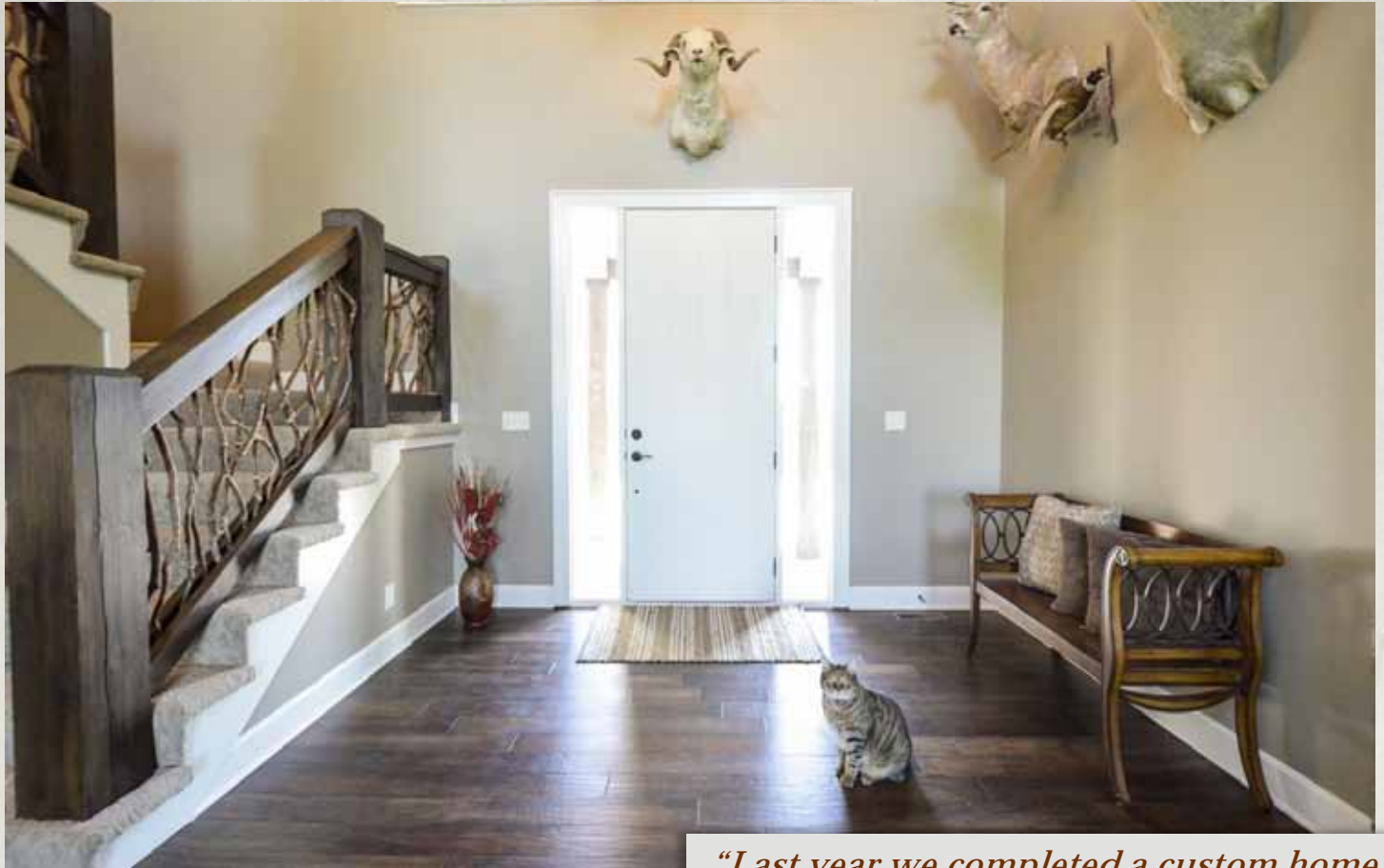

"Last year we completed a custom home that had your handrails installed. They look amazing so I wanted to forward you on some pictures of the project."
Charielle Sowers, Owen Homes LLC



"Thanks for everything, they look great. I'm quite sure you'll be seeing a few more orders from Big Sky, everyone is oohing and aahing over these. Thanks again, quality product!"
Jesse V.





"We bought some railing sections from James about 12 years ago for our cabin and they looked great! We recently sold our cabin and the railings were a feature that were a real selling point. Everyone who saw them always remarked how cool they looked." Chris B.

Continue the motif with a Mountain Laurel Branch Banister.



Mountain Laurel Branch Banister is approximately 2" diameter and each piece is unique. We provide the material cleaned and ready to end-join. Your contractor installs and end-joins on site and provides the mounting hardware.

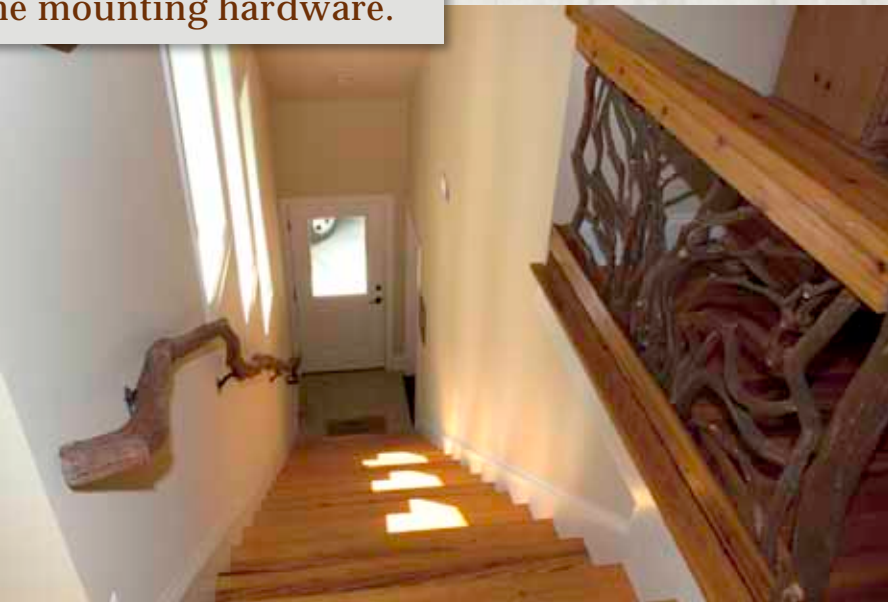

Curved Railing



The deck on this incredible home has two different curves.





“People are oohing and ahing over your handiwork. Thanks so much for sharing your skills with our family. You incorporated your artistic skills and creativeness into what turned out to be a most unique dwelling place. We adore our new house.” Missie P.





Mountain Laurel Handrail®
installed in Maui, Hawai'i

Log Railing



Log railings are available with a variety of different wood species and finish options. The project pictured here used machine-hewn white pine in 4" diameter with live-edge posts in 8" + diameter.



*"I am very pleased
with the construction
and look of the rails.
You were great to
work with."
Mark M.*

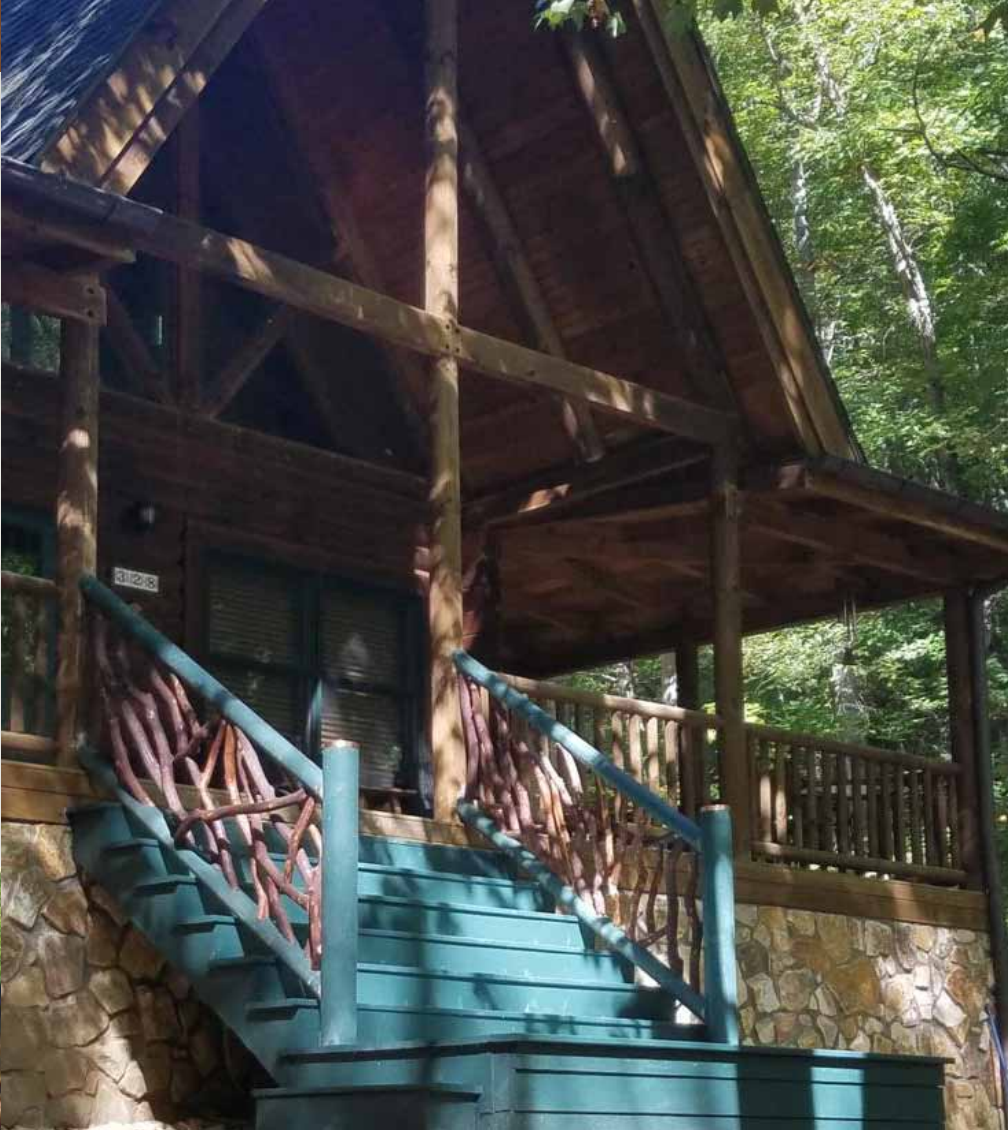

This project used turned white pine 4" on the rails and 6" on the newel posts.



The most popular log wood species is locust with the bark removed. Locust is a naturally durable wood, just like mountain laurel, so it's a great choice for exterior use.





This project used locust with the bark left on.



Log



35



The customer provided these custom-made mounting brackets which were attached to the top and bottom of turned 4" cedar rounds.



Custom Woodwork

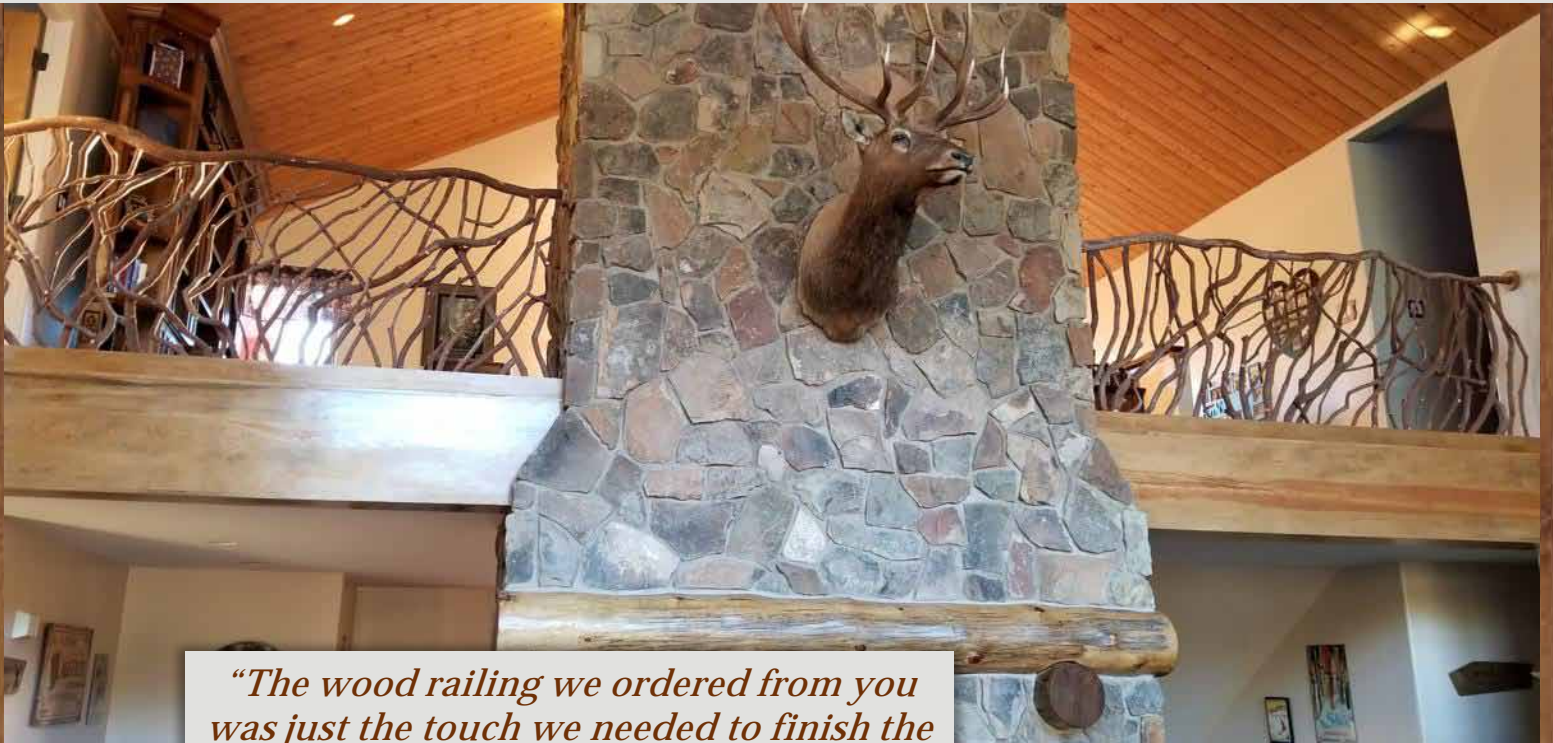

"The wood railing we ordered from you was just the touch we needed to finish the rebuild of our giant double sided fireplace and the stair rail and banister were the perfect way to create a transition from the first floor to the second. Everyone who visits comments about how cool the railings look. Thanks!"
Scott S.

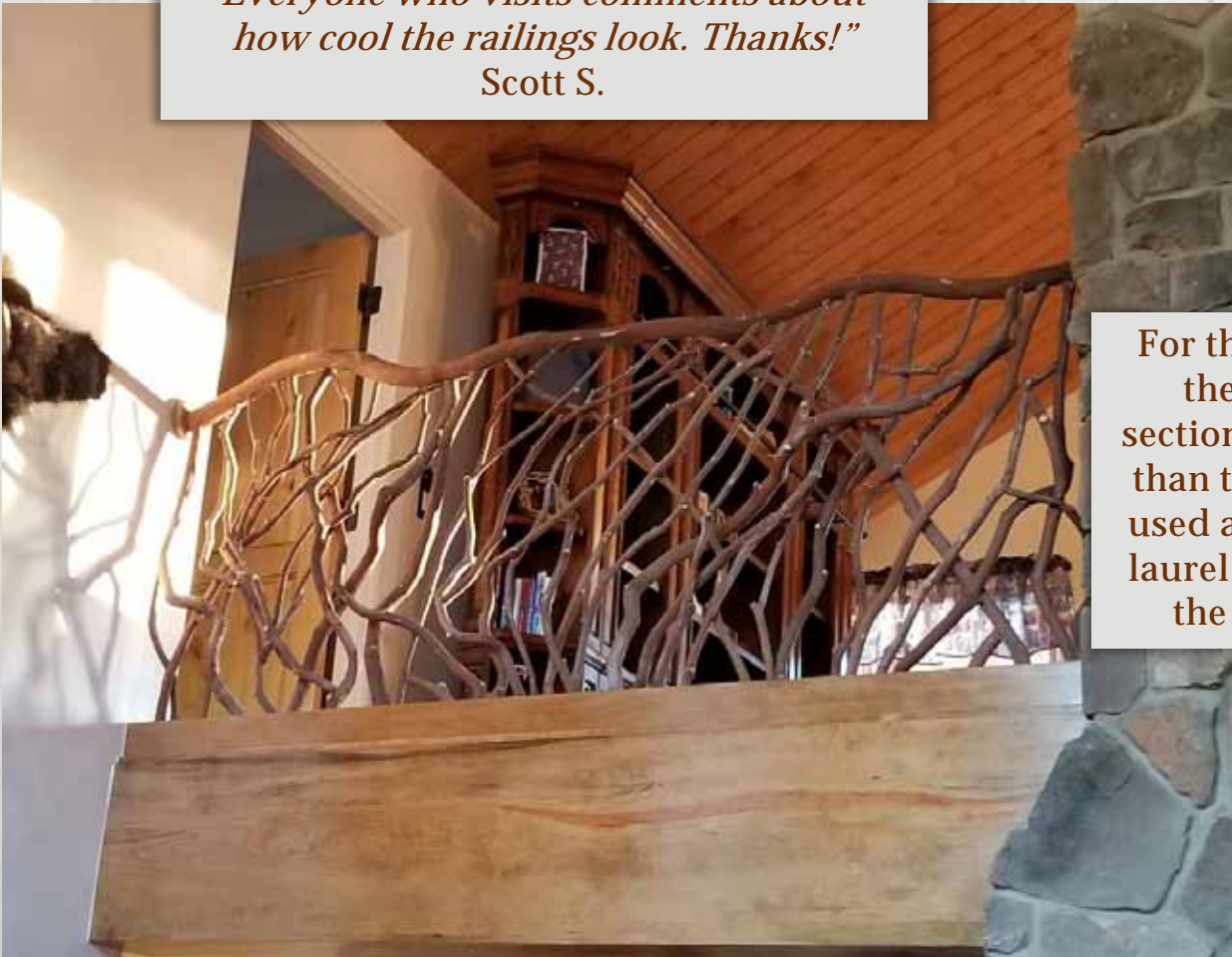

For this project, the railing sections are taller than typical and used a mountain laurel branch for the top rail.



"We just love our railing and as of today, it is installed. We will send you pictures over the weekend of the final product. Anyway, we just wanted to thank you for giving us a work of art to enjoy for a very long time." Laurel V.



The customer provided these hand carved birds which were incorporated into the design of the branch infill. The top and bottom rails were of reclaimed barn wood.



This project used two unique styles of railing. For the stairs, the top rail is a mountain laurel branch and the bottom rail is yellow pine 1x4. For the upstairs portion, the rails are pine 2x6 and the ends of the sticks are exposed.





*"It's great! I really appreciate it!!
You guys did a really great job on
the gate! Absolutely beautiful! :)
I can't wait to show my client!"*

Nichole Chaput,
LAT Greentree

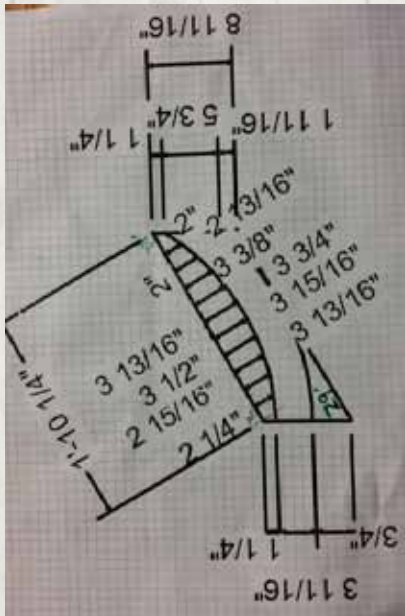

A custom-built
gate with 4x4
cedar timbers
and branch infill.

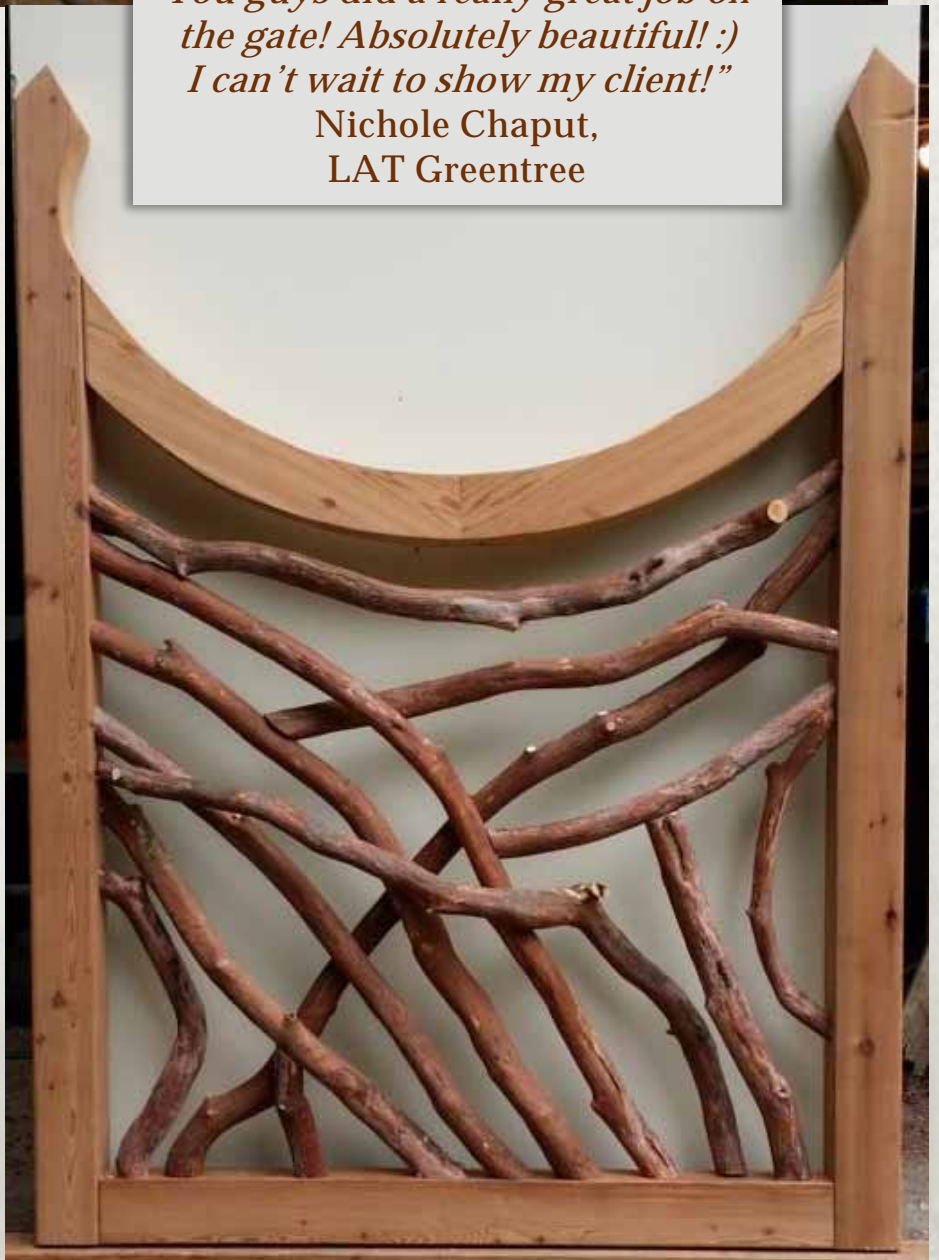



This railing section is 5 feet tall and the finished project incorporated a Mountain Laurel Newel Post.



Laurel Furniture



Custom built Laurel Furniture
is available upon request.





Railing Parts



Mountain Laurel Material is available in bundles of 10 sticks, approximately 8' long, from 0.5" to 1.5" diameter



Mountain Laurel Newel Posts add special flair to your project.



The Process



Mountain Laurel Handrails come in preassembled sections that are easy to install. You provide your actual post-to-post measurements. A typical section is a top and bottom cedar 2x4 with the mountain laurel branches woven in between.

Sections are built one inch longer than your actual post-to-post measurements. You provide an additional 2x4 top and bottom to make a “sandwich” of the ends of the sticks, as well as the 2x6 top. To quote your project, please provide your total linear footage and city/state for delivery.



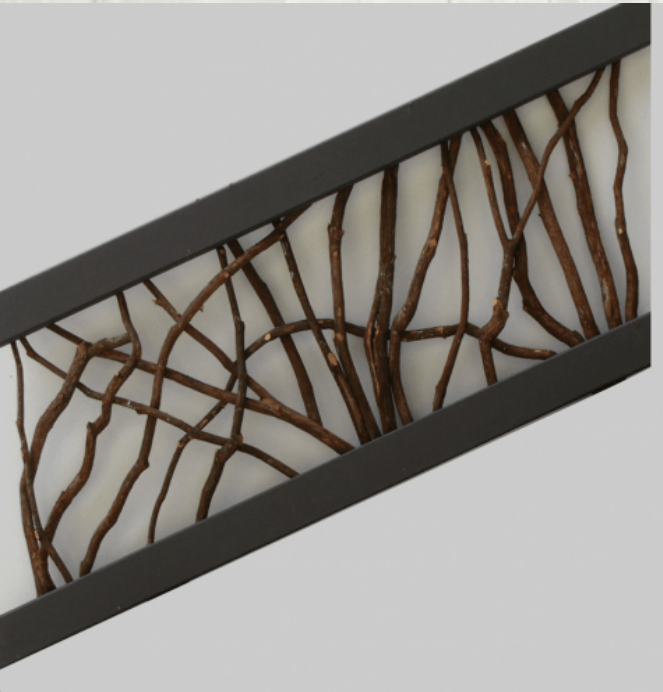

Stair railings are built to match the angle of your stairs. Measure as shown in the drawing and provide: long-to-short, height measured perpendicular or square to the angle of the stairs, and the angle in degrees. Also include which side of the stair the railing is on as you stand at the bottom and look up. All stairs are different, so precise measurements are important.

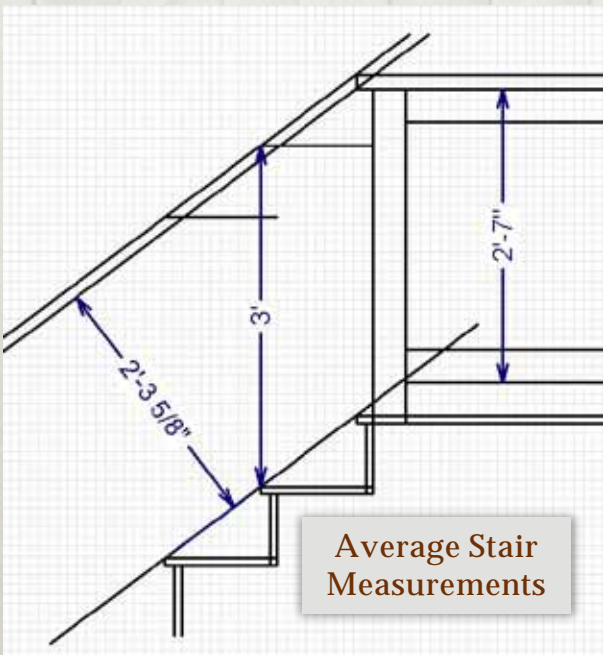

Average Stair Measurements

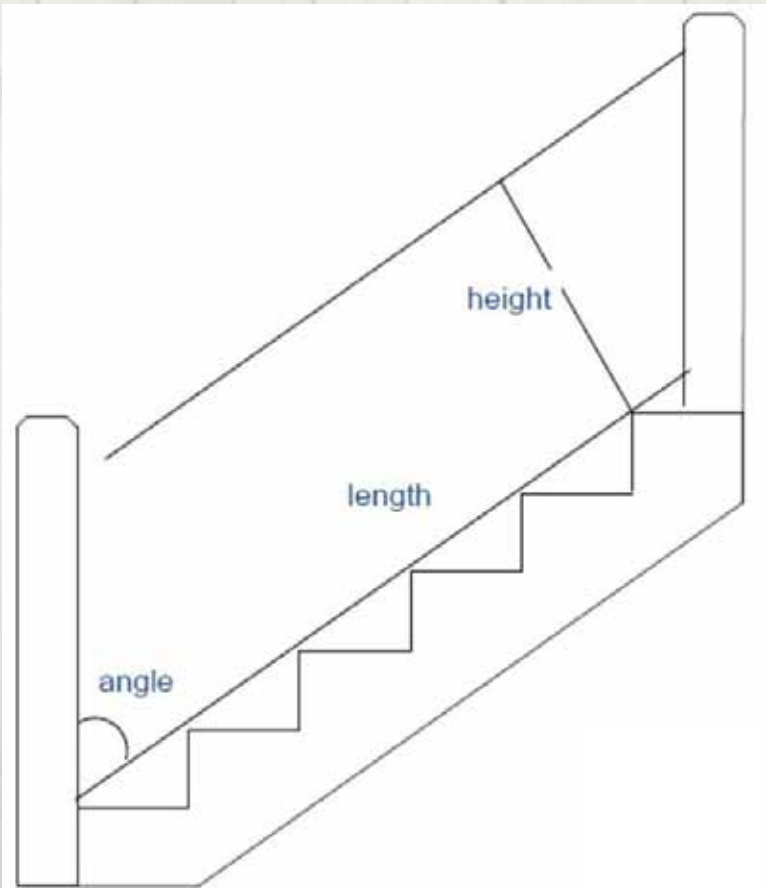

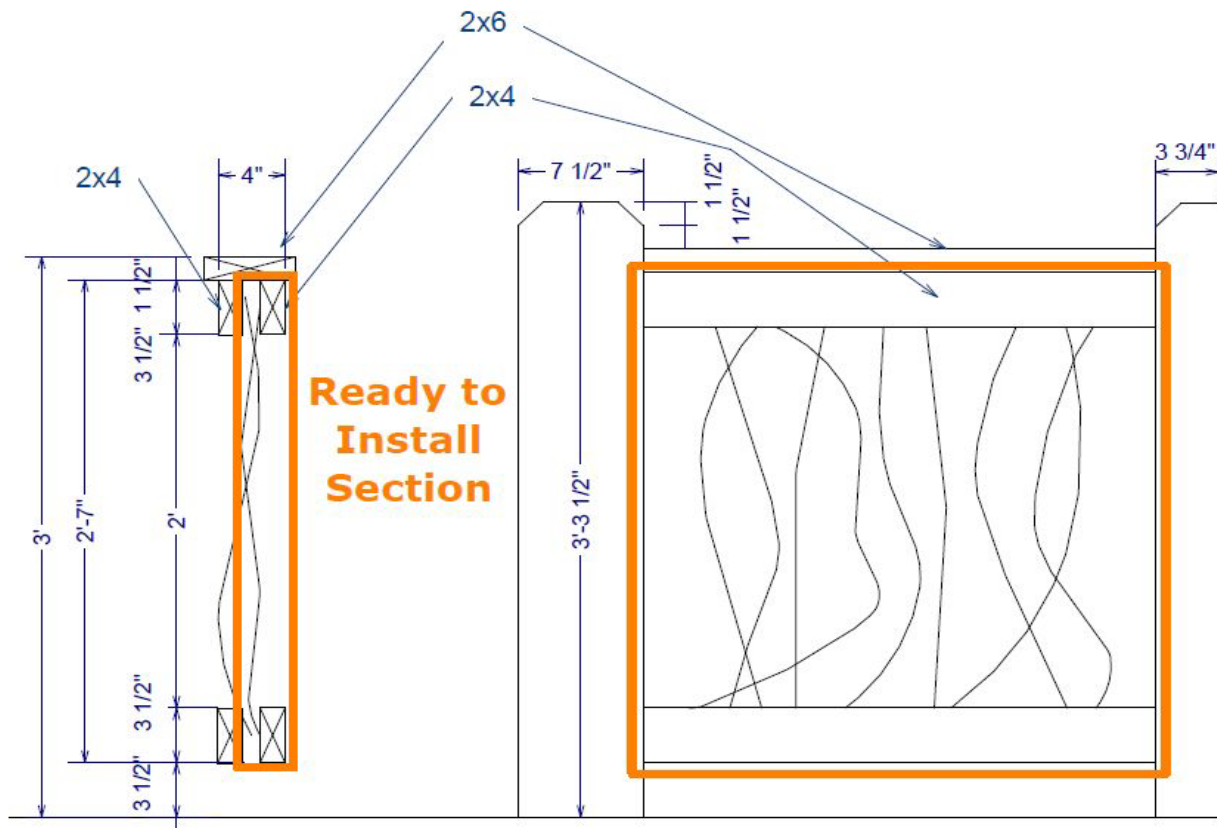

Typical Railing Installation

Additional 2x4s, 2x6, and posts not included.
All openings in woven branches less than 4" diameter.

Installation Instructions: Preassembled railings are easy to install!
(Section drawings for typical installation pictured above and actual section pictured below.)

Sections are built according to your post-to-post measurements and the 2x4s are left about one inch long. When the order arrives, rest sections on 2x4 blocks on edge, scribe and cut the ends of the top and bottom rails to match the posts, slide the section into place and fasten with screws. 2x4s are installed to sandwich the ends of the sticks at top and bottom. To finish, a 2x6 is installed as a top cap, placing all screws and fasteners to be hidden.

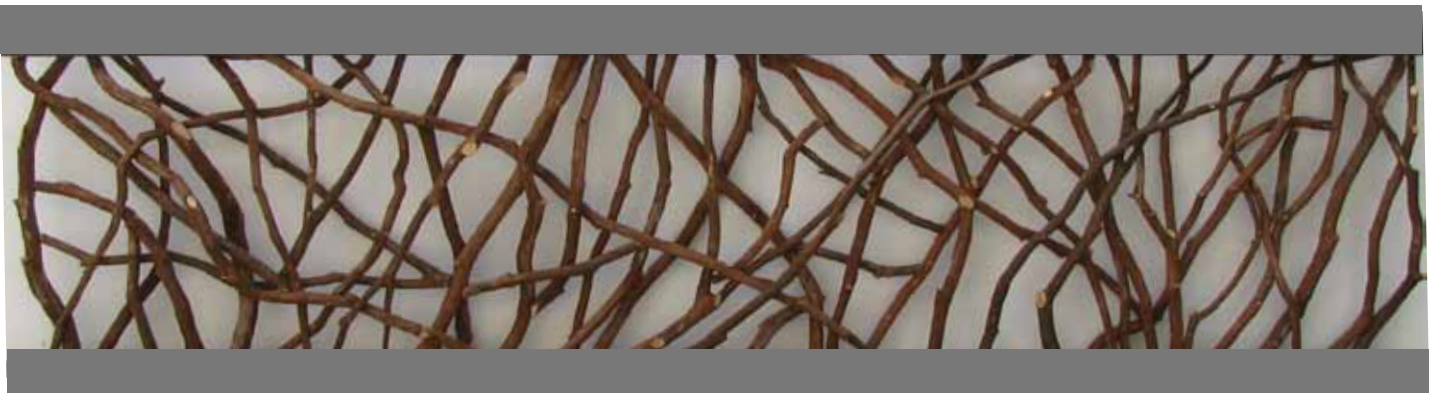

Mountain Laurel Handrail Section Preassembled and Ready to Install



Infill patterns are typically random weave. The only pattern available is the sunburst where the sticks radiate out from the center of the bottom rail. This pattern is available on special request. Large orders will typically have one or two sunburst sections.





Sticks are typically unfinished. Some people like a natural stain on the sticks since it brings out the red color and gives them a little bit of shine. Another option is paint on the sticks.



Red Cedar Lumber



White Pine Lumber

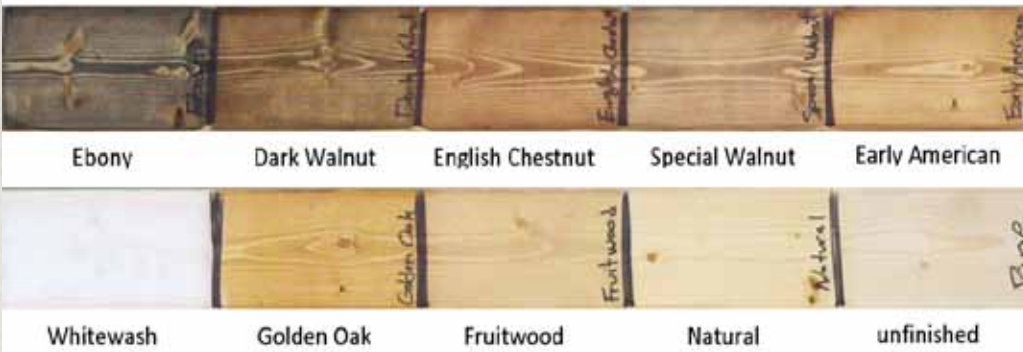

Paint or stain on the top and bottom rails is included in the price of the typical project. You specify the product and we get the same product to match what you're using. This picture shows some typical Minwax stain products applied to red cedar and white pine 2x4 lumber.

After we have finalized your order, it's typically 4 weeks until we ship. Orders are packaged in custom built palletized crates that fit in a pickup truck and can be moved by a forklift. Orders are shipped freight and delivery is typically made by a full-size, 53' tractor trailer.





When your order arrives on site, open the box and spread the sections out. Place each section on 2x4 blocks to space it off the floor. Mark the top and bottom, left and right, and cut the sections on your marks. Screw them into place, hiding fasteners on the inside as possible. You provide additional 2x4s to sandwich the ends of the sticks, top and bottom. You also provide the 2x6 top cap.



Information Needed to Order

- Name
- Delivery Address - Accessible to full size tractor trailer
- Delivery Phone Number - Delivery driver should call to schedule delivery
- Lumber Type - Typically smooth western red cedar #2
- Lumber Dimensions - Typically 1x4 or 2x4 depending on post dimensions
- Finish Type - Paint, Stain or Unfinished
- Finish Manufacturer - Product, Color, Tint/Sheen, etc
- Regular Section Lengths
- Regular Section Height - Typically 31" for a finish height of 36"
- Stairs Section Lengths
- Stairs Section Height - Measure as shown in the drawing
- Stairs Section Angle
- Stairs Section Side of Stairs - As you stand at the bottom and look up
- Desired options, if any
- Payment in full, via check by mail or credit card online

Installation Instructions

1. Remove sections from package
2. Place 2x4 blocks on edge by posts
3. Place sections on blocks by posts
4. Mark ends of sections and cut to fit
5. Slide sections into place
6. Screw to post with appropriate size screw
7. Cut 2x4s (not included) to size
8. Use finish nail gun to nail 2x4 into fatter diameter sticks
9. Screw or nail 2x4 to posts
10. Cut 2x6 top cap (not included) to length
11. Use trim head screws and angle upwards through the 2x4s into the bottom of the 2x6 for a fastener free top
12. Also screw the 2x6 into the posts as possible

Railing Styles

Mountain Laurel Handrail – The typical installation: mountain laurel sticks are woven into intricate patterns between 2x4 smooth red cedar boards. Sections are finished with two 2x4s and a 2x6 top cap.

The Lissara – Sections are framed with a vertical smooth red cedar 2x4 on either side and 1x2 top and bottom rails to create a shadow line of the same width around the entire panel. Panels are installed between horizontal 2x6s top and bottom.

Great Smoky – Top and bottom rails are whole rounds or natural logs. Peeled logs can be stained or painted. Mountain laurel sticks are coped to match the curve of the log.



Other Options

Wood Species – Sticks are of Mountain Laurel. Default dimensional lumber is smooth red cedar 2x4. Inquire for other species and/or surface treatments.

Paint or Stain – Paint or stain of dimensional lumber is included. Inquire for paint or stain on mountain laurel sticks. Unfinished sticks weather to a silver color.

MOUNTAIN LAUREL HANDRAIL[®]

Mountain Laurel Handrails are unique guardrails for residential and commercial buildings. These woven branch railings are custom-crafted by skilled artisans in the Great Smoky Mountains. Mountain Laurel Handrails are available delivered to job sites nationwide.

There is no better or easier way to instantly enhance the exterior façade and curb appeal of a building. Each railing section is built to specification and the typical railing can be modified to match any design. Custom options include dimensional lumber species, stain or paint on the sticks, modified railing design, and log rails.

Mountain Laurel Handrails are a perfect fit for a rustic styled log or timber frame building but also work well with more modern décor. Since handrail sections arrive preassembled and ready-to-install, AND are easily installed by a skilled carpenter, construction cycle time is shortened and labor costs are significantly less than site-built systems.

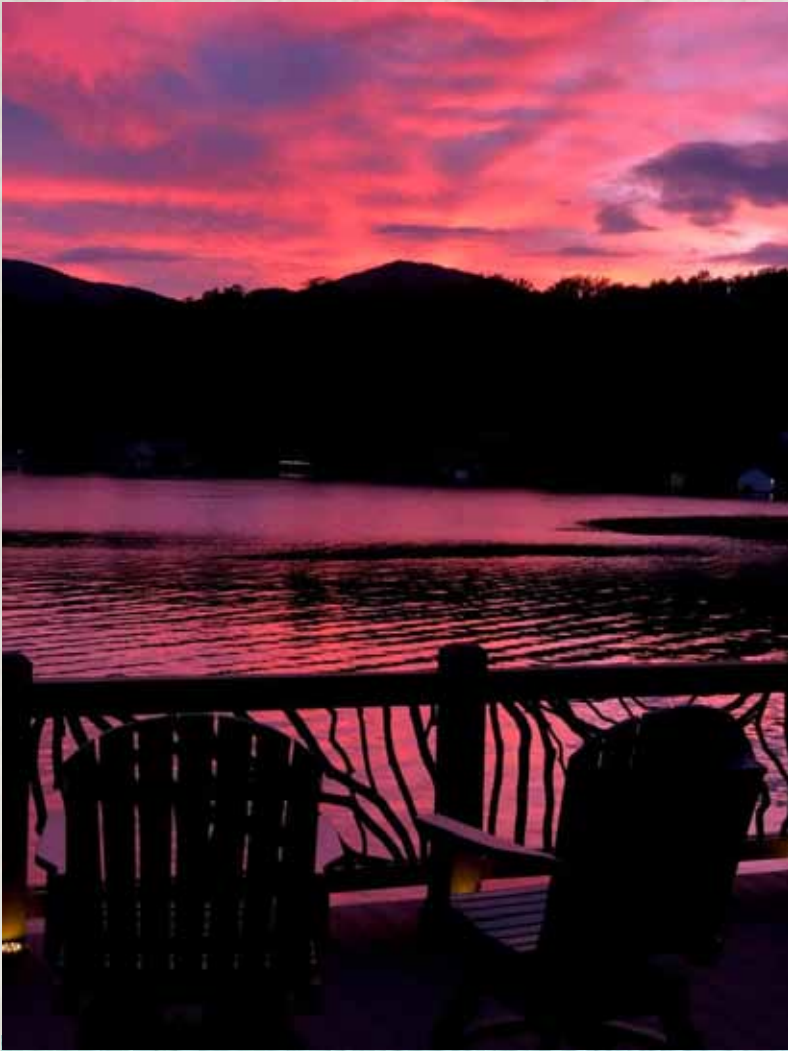

MOUNTAIN LAUREL HANDRAIL[®]



Inspiration Gallery



awoodrailing.com
info@awoodrailing.com
828-342-0873